

ANT S.r.l. Via della Concordia, 4 – 37036 S. Martino B/A (VR) - Italia Tel. +39 045 8781380 e-mail: commerciale@antsrl.eu www.antsrl.eu	DESCRIPTION	
	205 MHz collinear antenna with aluminium base and fiberglass mast Suitable for Digital Audio Broadcasting	

OC-5dBi-205

P/N: M10-002

ELECTRICAL DATA

Frequency Range: (to be tuned on request)	180 / 230 MHz
Impedance:	50 Ω
V.S.W.R. at 169MHz:	<1.5 : 1
Max Power:	150 W
Polarisation:	Linear
Radiation:	Omnidirectional
Gain:	5 dBi
Electrical downtilt	6°
E-plane Beamwidth -3 dB:	43°
H-plane Beamwidth -3 dB :	360°
Lighting protection	DC-grounded

MECHANICAL DATA

Length (about):	2000 mm
Connection:	N socket (extension on request)
Cable:	
Operating temperature range:	-35° / +80°C
Weight (about):	1.9 kg
Radiating element material:	Copper, brass
Radome material:	Glass fiber radome (Ø22 mm)
Base material:	Galvanised aluminium
Accessories:	Clamps for mounting on pole

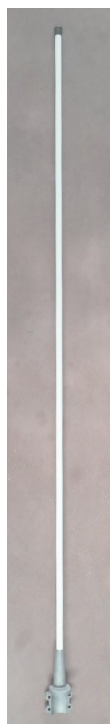

Protection against static electricity: The antenna is designed with the rod electrically connected to the mass, so that the antenna is protected against electrostatic discharges.

Protection against oxidation: The antenna is designed to be able to withstand the worst climatic conditions and so that the oxidation of its components is prevented.

RoHS Directive: The antenna complies with the RoHS Directive and its subsequent.

MOUNTING INSTRUCTONS

Pole Mounting: Please use the provided mounting clamps for mounting on pole Ø min. 30 mm (1 inch) max 60 mm (2 inches).

ANT S.r.l.

Via della Concordia, 4 – 37036
S. Martino B/A (VR) - Italia
Tel. +39 045 8781380
e-mail: commerciale@antsrl.eu
www.antsrl.eu

DESCRIPTION

**205 MHz collinear antenna
with aluminium base and fiberglass mast**
Suitable for Digital Audio Broadcasting



OC-5dBi-205

P/N: M10-002

3D radiation simulation

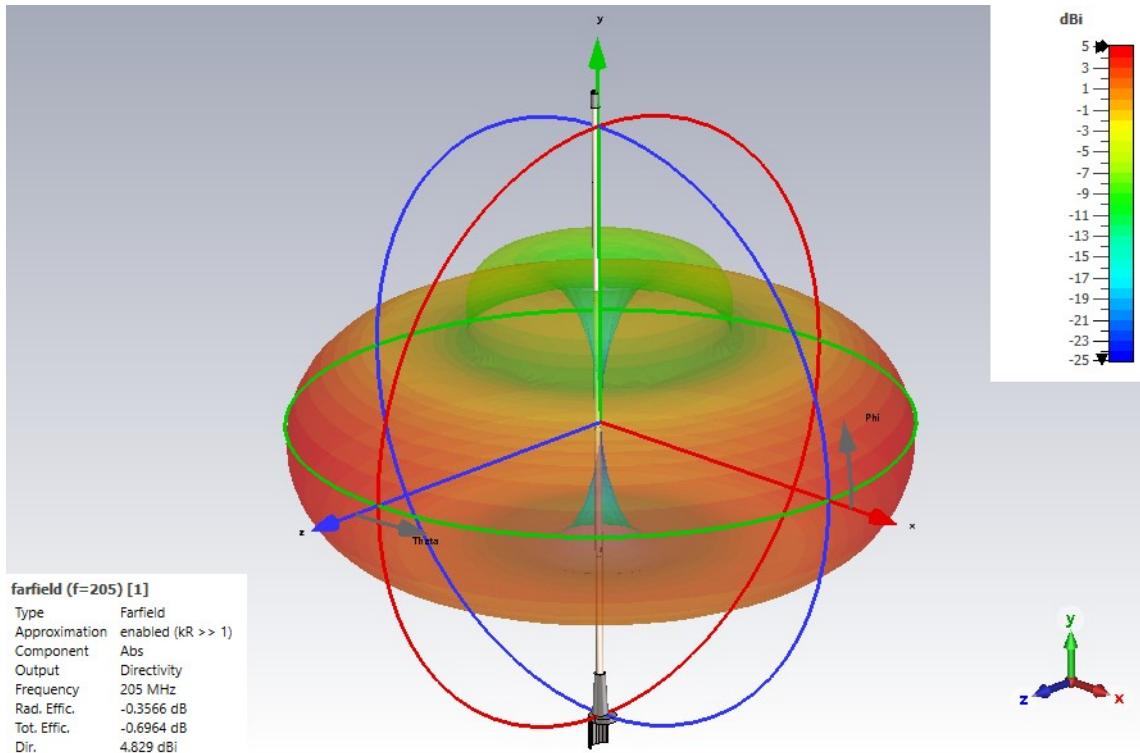

Radiating patterns

VSWR

H-Plane

E-Plane

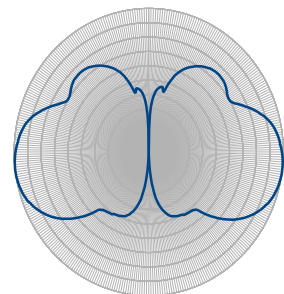
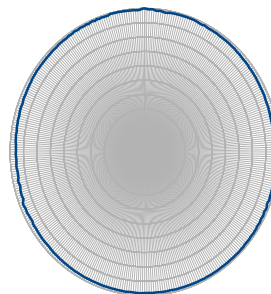
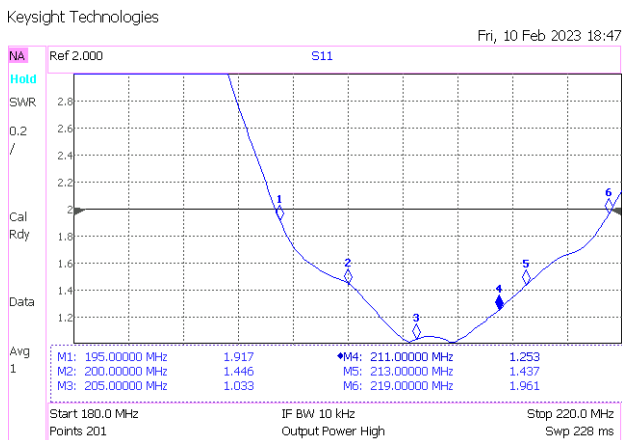

ANT S.r.l. si riserva di apportare modifiche e miglioramenti in qualsiasi momento senza obbligo di preavviso
ANT S.r.l. reserves the right to change or improve this documentation at all times and without notice.

ENG-Rev. 0

ANT S.r.l.

Via della Concordia, 4 – 37036
S. Martino B/A (VR) - Italia
Tel. +39 045 8781380
e-mail: commerciale@antsrl.eu
www.antsrl.eu

DESCRIPTION

205 MHz collinear antenna
with aluminium base and fiberglass mast
Suitable for Digital Audio Broadcasting

**OC-5dBi-205**

P/N: M10-002

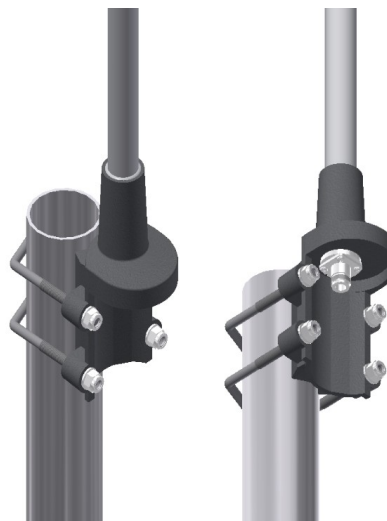
MOUNTING ON POLE Ø30-60mm**MOUNTING ON POLE (EXTERN.)**
Ø30-Ø60mm**MOUNTING ON POLE (INTERN.)**
Ø40-Ø60mm